

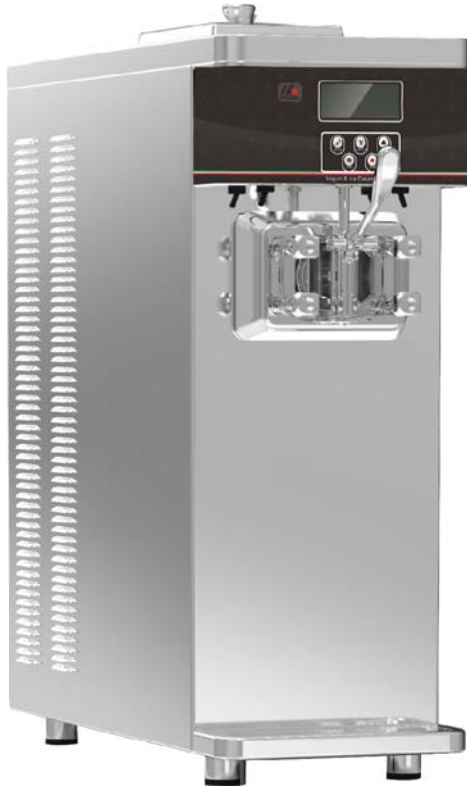

Model: TC302S

Soft Serve Freezer Single Flavor, Table Top



Offer all the popular soft serve variations from low or non-fat ice creams to custards, yogurt and sorbet.



Pre-cooling System

Dual pre-cooling in both freezing cylinder (one, 2.0 liter) and hopper (one, 14.0 liter).



Standby/Overnight

During long no-use periods, the standby feature maintains safe product temperatures in the mix hopper and freezing cylinder.



Agitator/Hopper Mixer

Agitator function in hopper keeps mix from separation over time.



Indicator Lights

The Mix Low light alerts the operator to add mix.



Counter Function

The numbers on display board shows the dispensed quantity everyday.



Hardness Adjustable

Hardness is adjustable according to different kinds of mix.



Shenzhen Taycool Refrigeration Tech Co.,Ltd.
Add 7/BLDG,Datong Industry Park, Louming Rd.
Guangming New Industry District, Shenzhen, China.
Tel: +86 27116370 info@frozenyogurt.org.cn
Fax: +86 27187851 www.icecream-taycool.com

100% 
DESIGNED
BY ITALY

TC302S Soft Serve Freezer

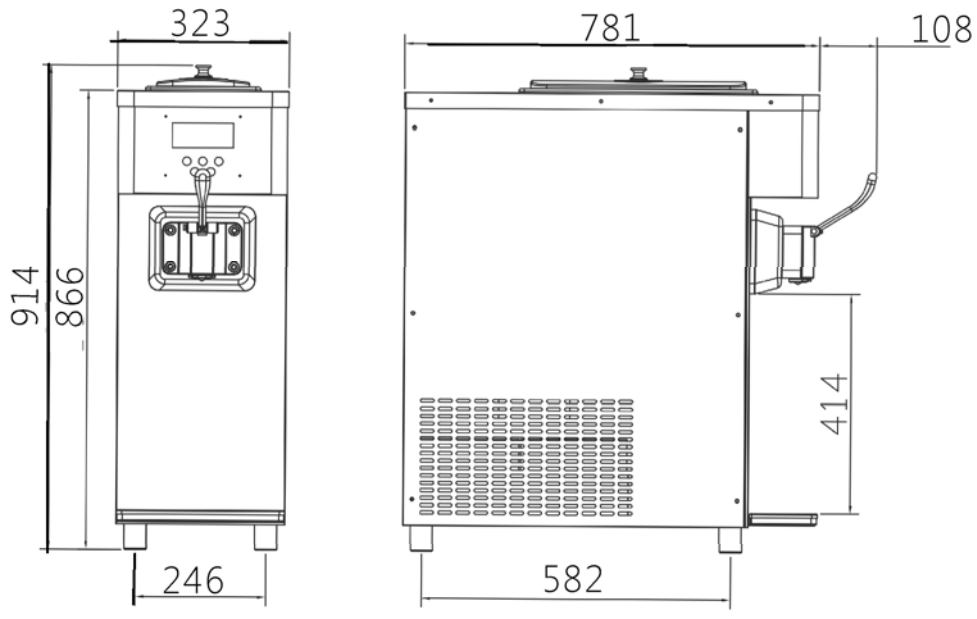

Weights kgs.

Net 105

Crated 124

cu.m.

Volume 0.23

Dimensions mm.

Width 323

Depth 781

Height 914

Power Supply

Phase 1~







Volt 220V

Hertz 50/60

Power 1750

For exact electrical information, always refer to the data label of the unit.

Selling Point

-  Low Noise Tech
50dB
-  Keep Fresh Tech
-  Frequency Converter Tech
-  Defrost Tech
-  Higher Efficient Refrigeration Tech
-  Low-energy-consuming Tech
-  Perfect Continuity of Dispensing Tech

